

- |           |                                    |           |                                |
|-----------|------------------------------------|-----------|--------------------------------|
| <b>D</b>  | <b>Montageanleitung</b>            | <b>GB</b> | <b>Assembly instructions</b>   |
| <b>FR</b> | <b>Notice de montage</b>           | <b>IT</b> | <b>Istruzioni di montaggio</b> |
| <b>NL</b> | <b>Handleiding voor de montage</b> | <b>PL</b> | <b>Instrukcja montażu</b>      |
| <b>CZ</b> | <b>Montážní návod</b>              | <b>SK</b> | <b>Návod na montáž</b>         |
| <b>HU</b> | <b>Szerelési útmutató</b>          | <b>RO</b> | <b>Instrukțiuni de montaj</b>  |
| <b>TR</b> | <b>Montaj talimatı</b>             | <b>RU</b> | <b>Инструкция по монтажу</b>   |

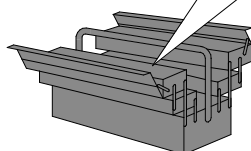
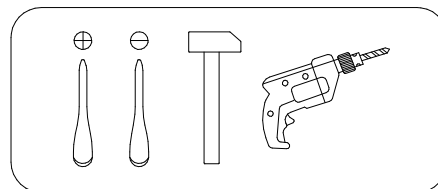
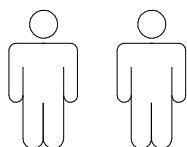

# Service · Dienstverlening · Serwis · Servis · Сервисная служба

Name · Naam · Nazwa · Isim · Название

Nr. · No. · Номер

Typ · Type · Tip · Тип

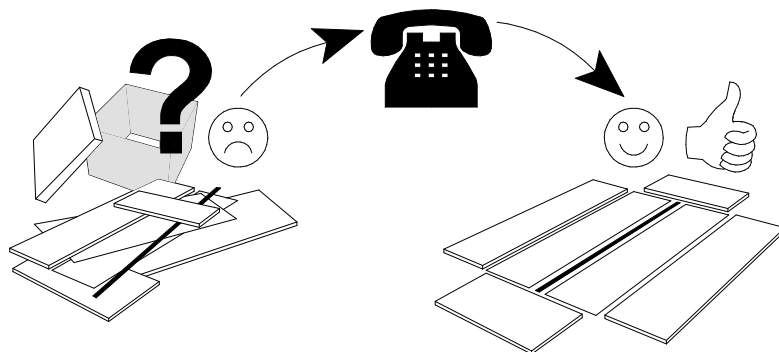
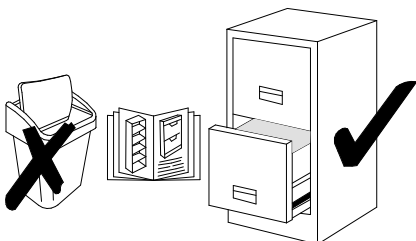



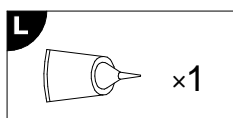
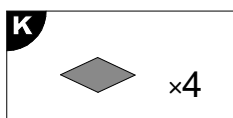
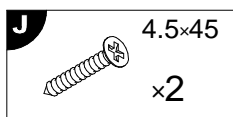
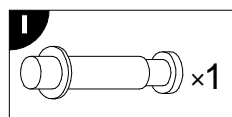
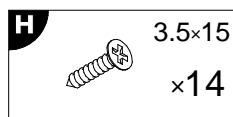
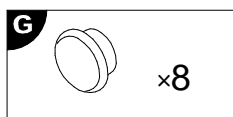
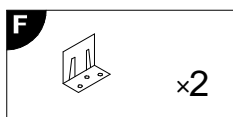
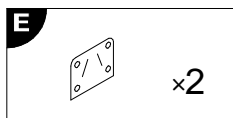
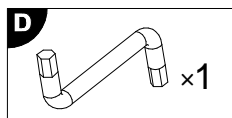
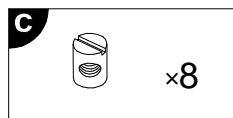
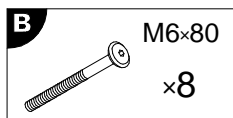
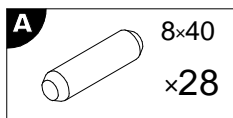
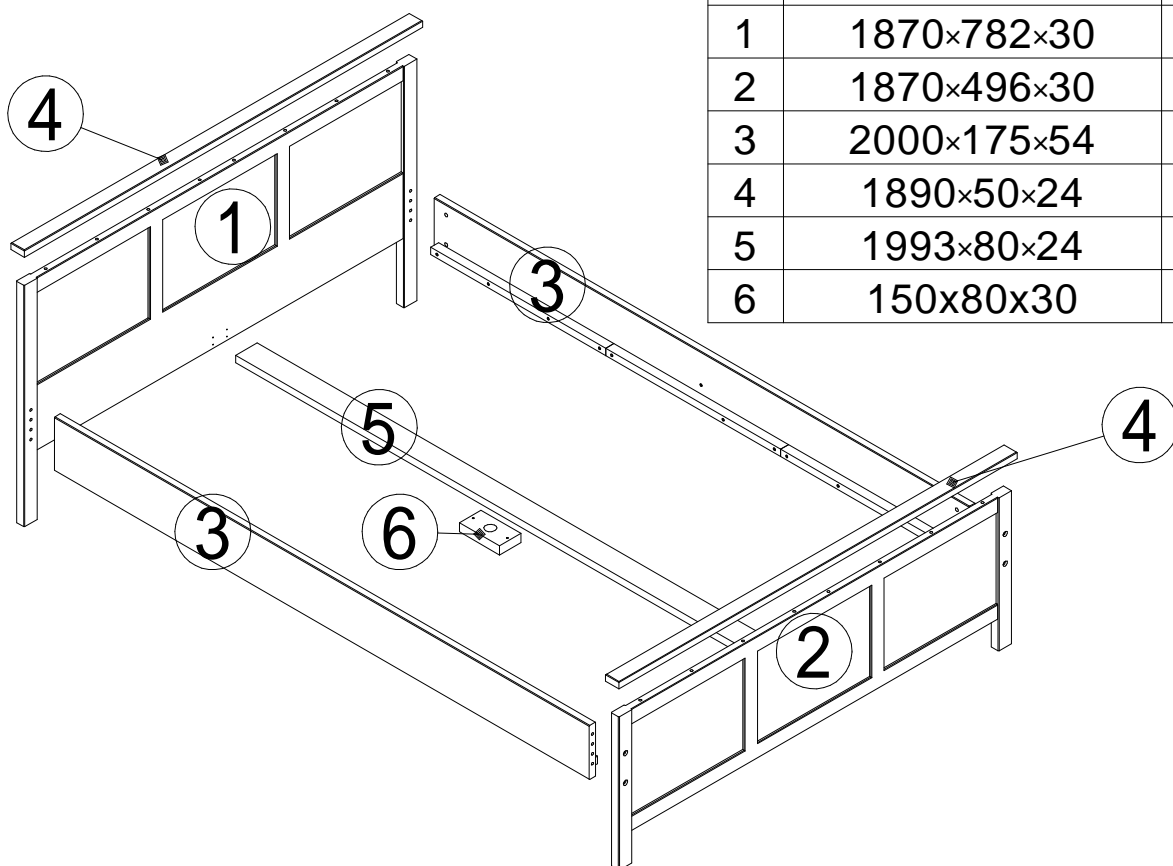

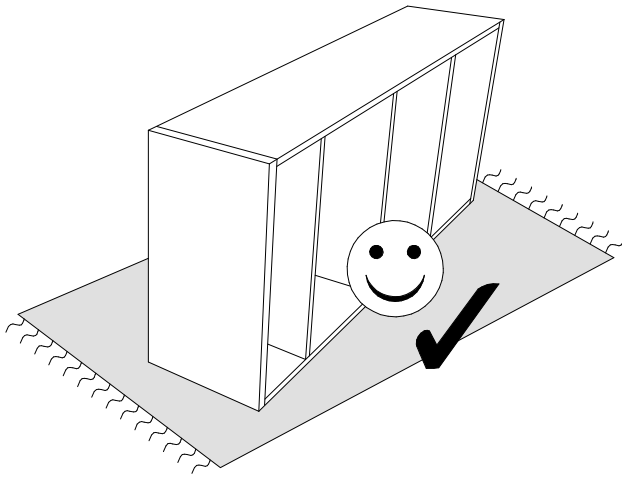

N	Size/MaB (mm)	Qty	✓
1	1870×782×30	1	
2	1870×496×30	1	
3	2000×175×54	2	
4	1890×50×24	2	
5	1993×80×24	1	
6	150x80x30	1	

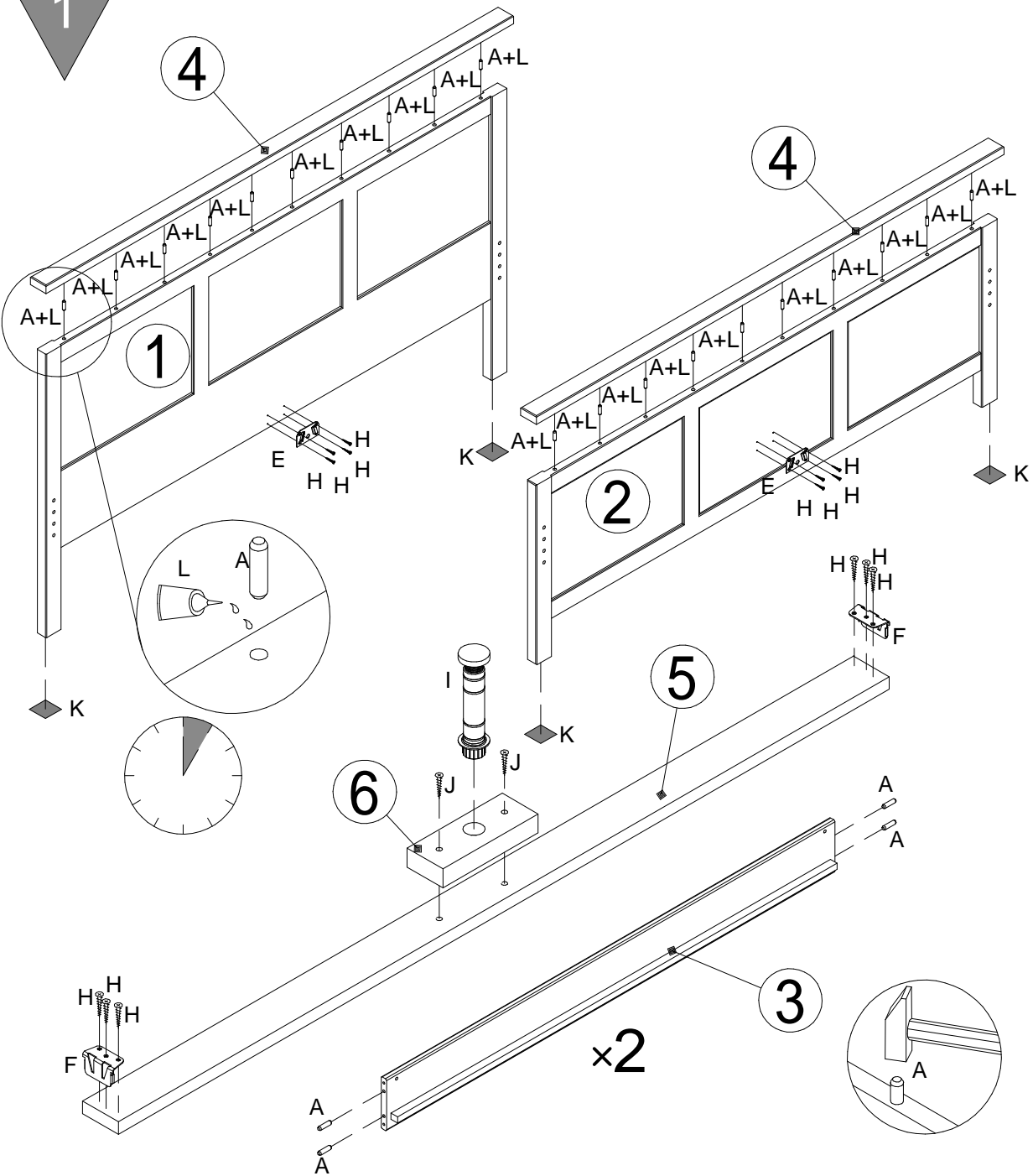

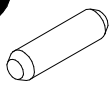
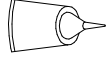
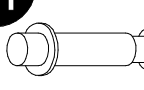

1



- E**  x2
- H**  3.5x15  
x14
- A**  8x40  
x28
- L**  x1
- D** Leim    CZ Lepidlo  
GB Glue    SK Glej  
FR Colle    HU Enyv  
IT Colla    RO Adeziv  
NL Lijm    RU Клей  
PL Klej    TR Tutkal
- I**  x1
- J**  4.5x45  
x2
- K**  x4
- F**  x2

