

D Montageanleitung

GB Assembly instructions

CZ Montážní návod

SK Návod na montáž

FR Notice de montage

IT Istruzioni di montaggio

HU Szerelési útmutató

RO Instrucțiuni de montaj

NL Handleiding voor de montage

PL Instrukcja montażu

TR Montaj talimatı



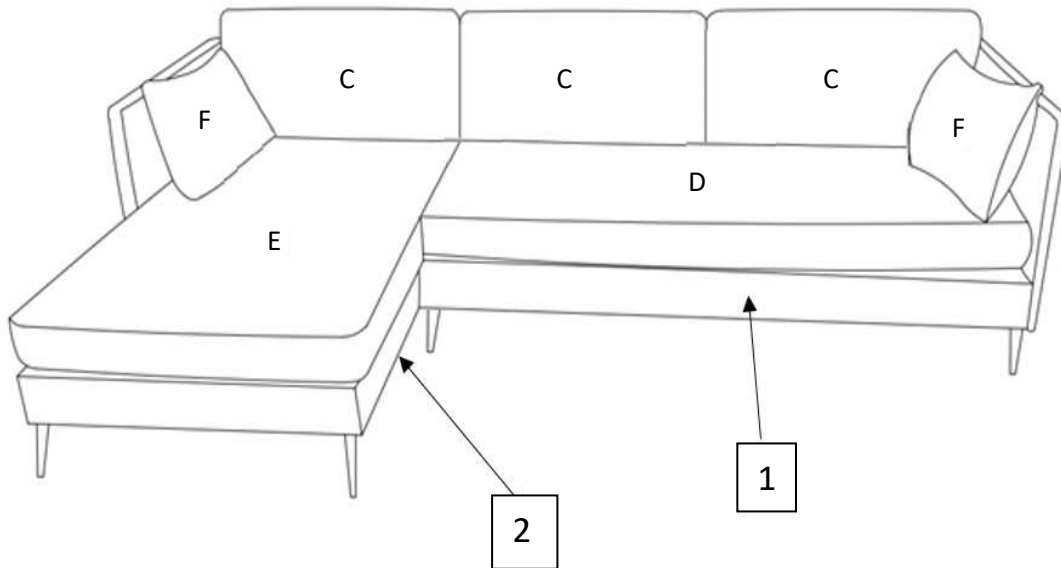
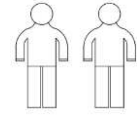

RU Инструкция по монтажу

LOFT CORNER LEFT

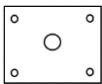
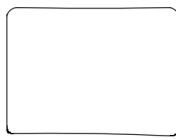

GR 1
54x165x96
Ax4
Bx4
Cx2
Dx1
Fx1

GR 2
54x83x164
Ax4
Bx4
Cx1
Ex1
Fx1

 A	8x	 B	8x	 C	3x	 D	1x
 E	1x	 F	2x				

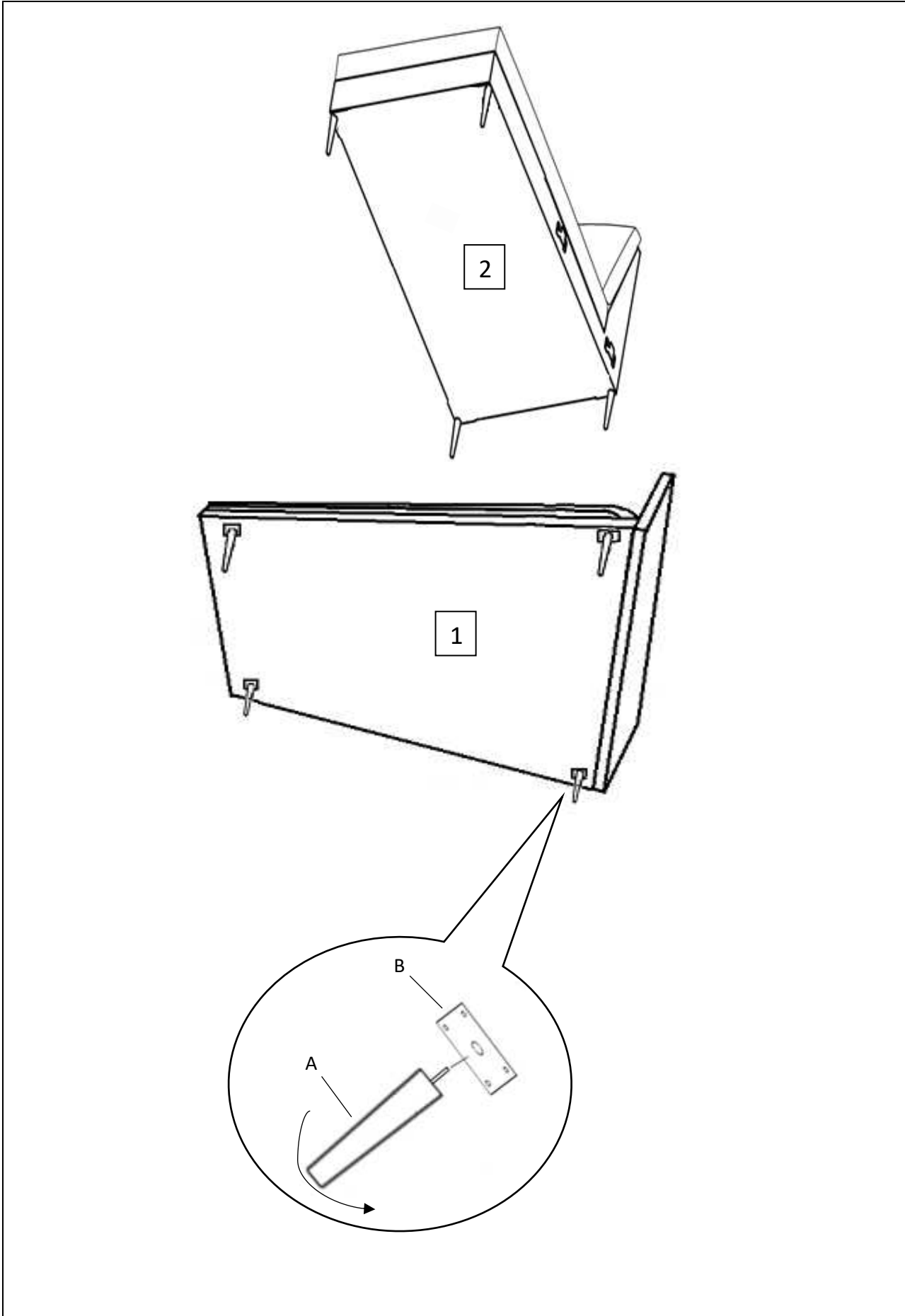

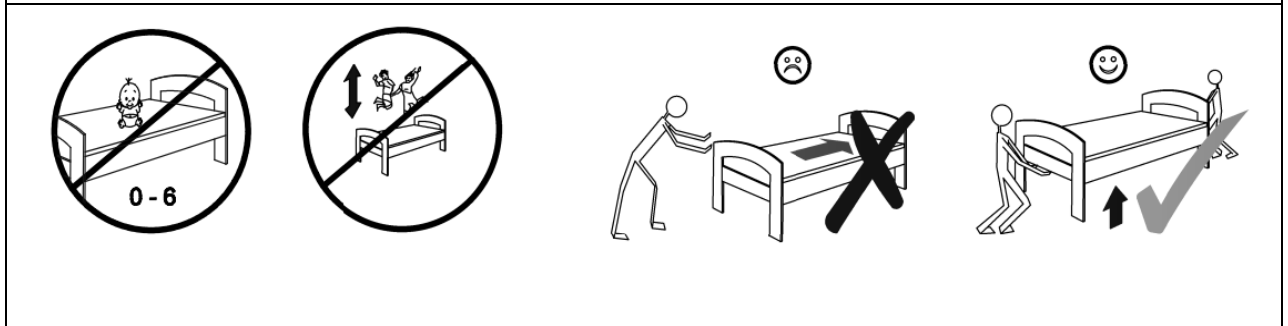
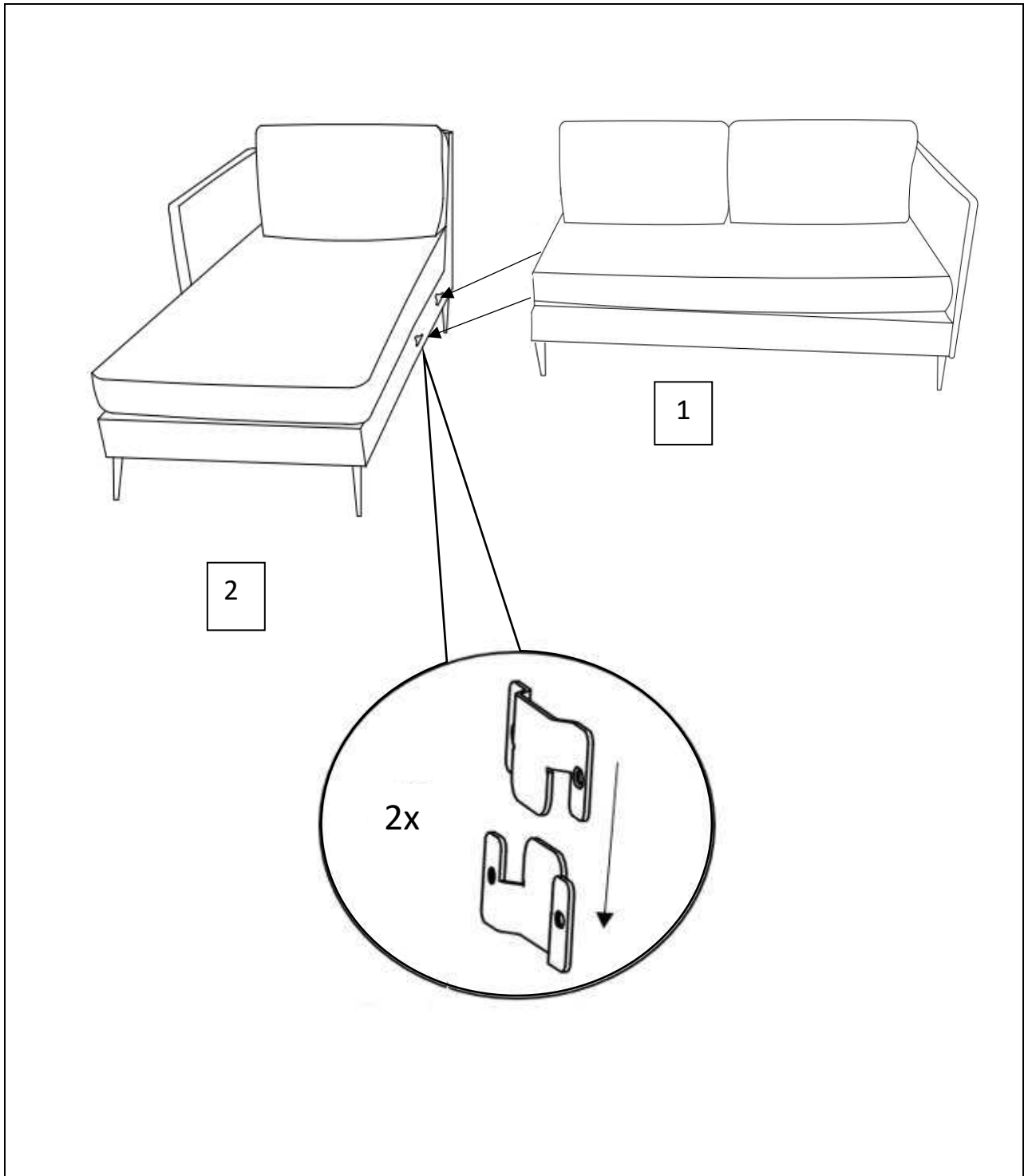

**Service • Assistenza • Dienstverlening • Serwis
Servis • Szerviz • Сервисная служба**

Name • Naam • Nazwa • İsim • Название

LOFT

Nr. • No. • Номер

Тур • Туре • Тір • Тип

CORNER LEFT

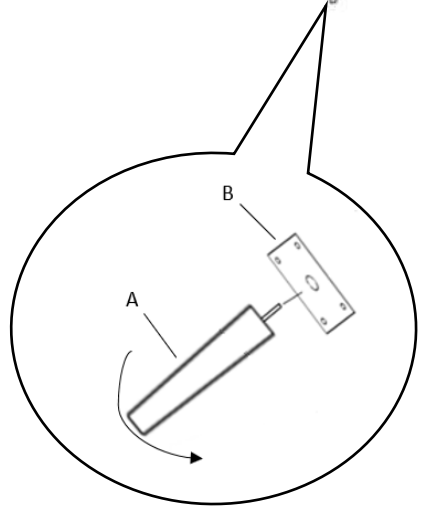
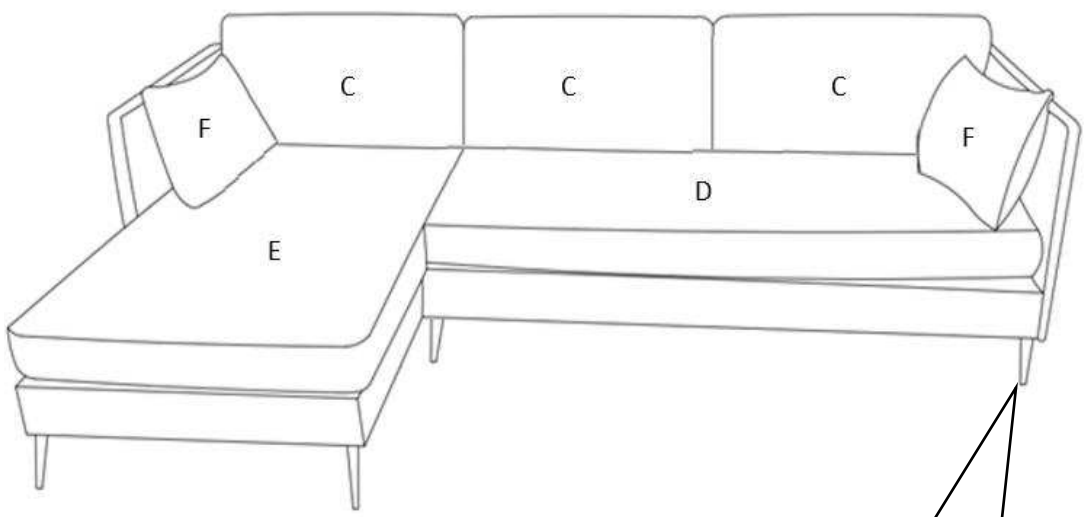
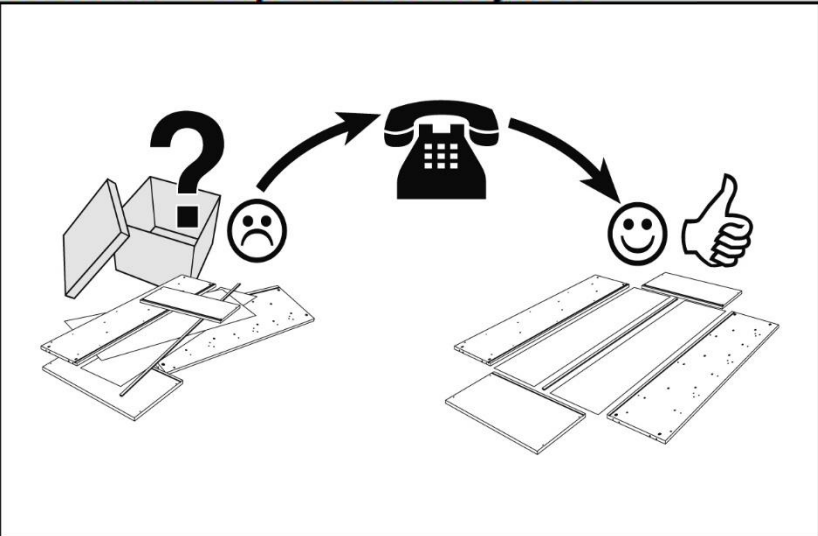
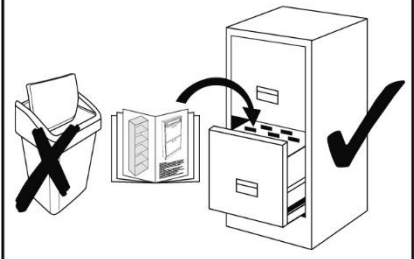

A	B	C	D	E	F