

- |           |                             |           |                         |
|-----------|-----------------------------|-----------|-------------------------|
| <b>D</b>  | Montageanleitung            | <b>GB</b> | Assembly instructions   |
| <b>FR</b> | Notice de montage           | <b>IT</b> | Istruzioni di montaggio |
| <b>NL</b> | Handleiding voor de montage | <b>PL</b> | Instrukcja montażu      |
| <b>CZ</b> | Montážní návod              | <b>SK</b> | Návod na montáž         |
| <b>HU</b> | Szerelési útmutató          | <b>RO</b> | Instrucțiuni de montaj  |
| <b>TR</b> | Montaj talimatı             | <b>RU</b> | Инструкция по монтажу   |

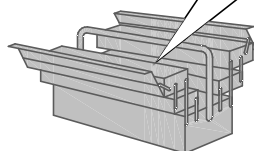
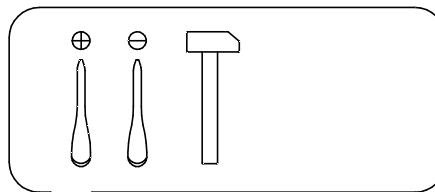

# Service · Dienstverlening · Serwis · Servis · Сервисная служба

Name · Naam · Nazwa · Isim · Название

№12707 Номер

Тип · Type · Tip · Тип



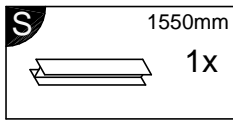
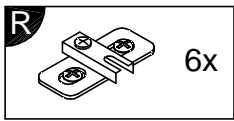
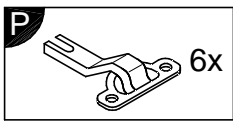
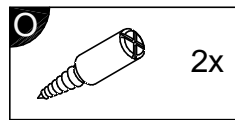
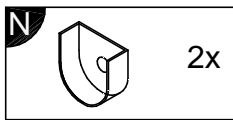
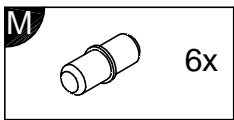
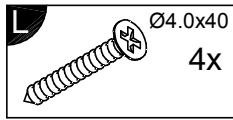
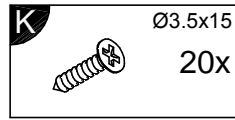
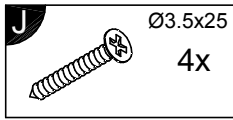
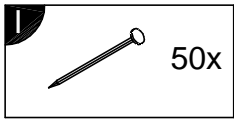
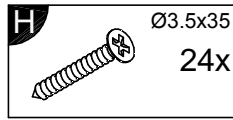
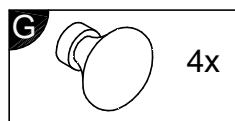
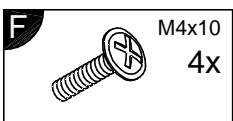
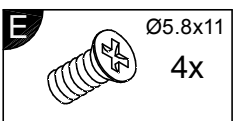
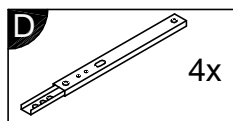
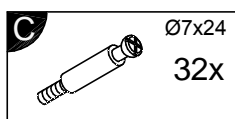
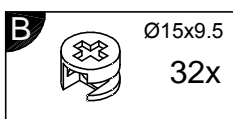
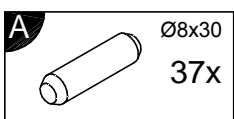
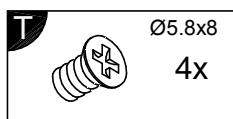
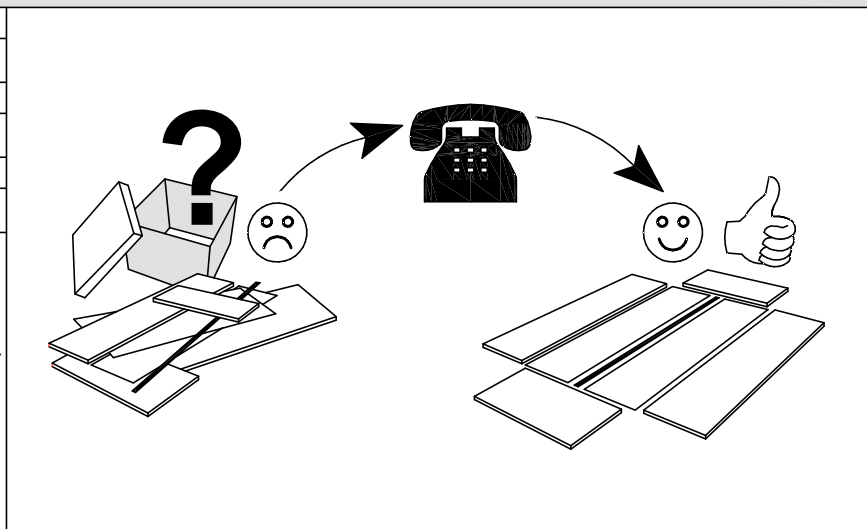
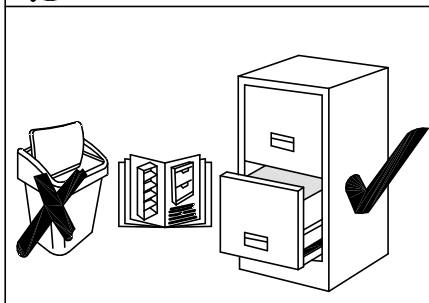

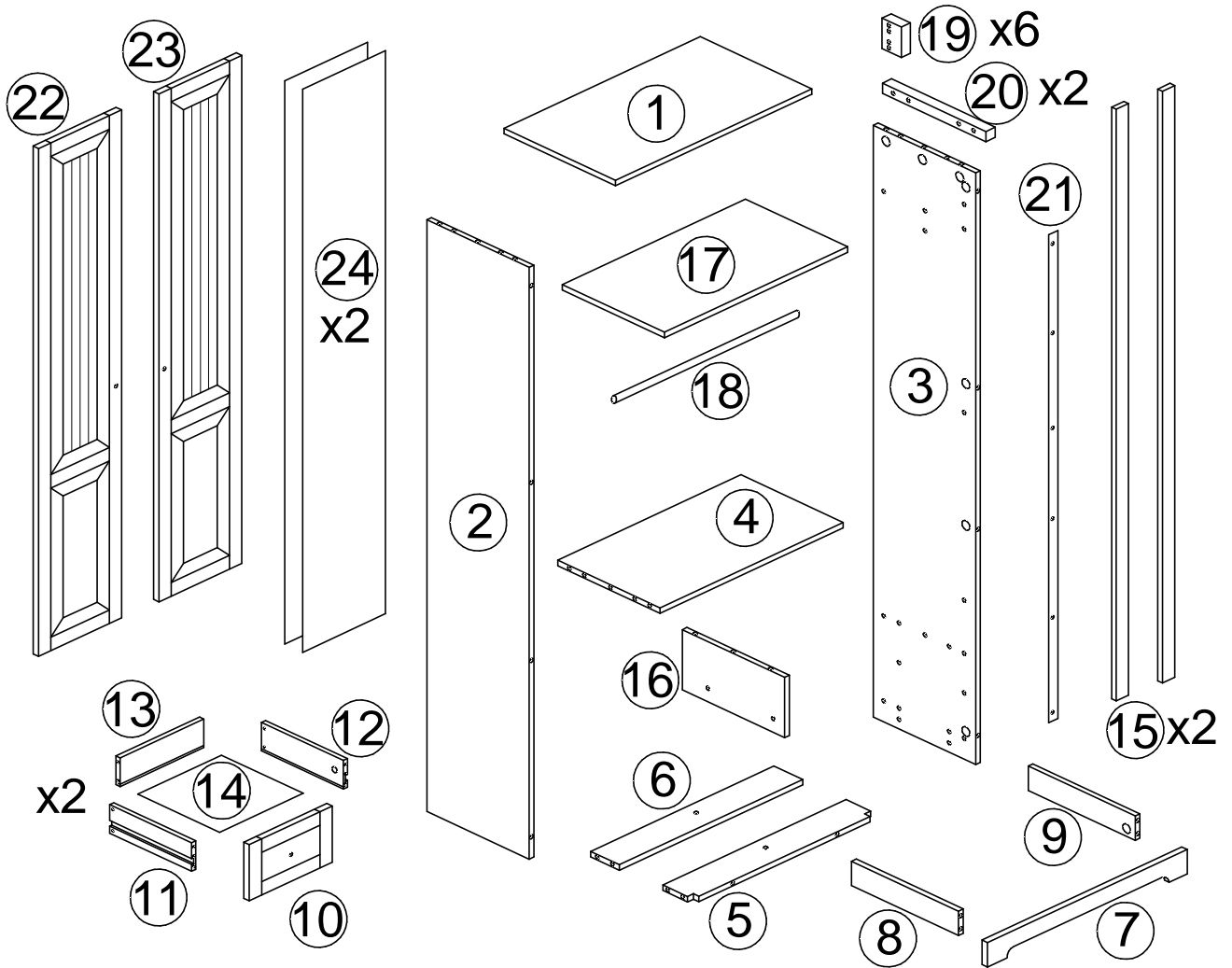

Nr	Size/MaB (mm)	Qty	✓
1	880 x 530 x 27	1	
2	1773 x 486 x 14	1	
3	1773 x 486 x 14	1	
4	792 x 481 x 14	1	
5	792 x 120 x 14	1	
6	792 x 120 x 14	1	
7	849 x 70 x 14	1	
8	504 x 70 x 14	1	
9	504 x 70 x 14	1	
10	365 x 140 x 18	2	
11	310 x 94 x 12	2	
12	310 x 94 x 12	2	

Nr	Size/MaB (mm)	Qty	✓
13	315 x 94 x 12	2	
14	305 x 323 x 3.2	2	
15	1773 x 42 x 18	2	
16	137 x 481 x 18	1	
17	790 x 470 x 14	1	
18	786 x 30 x 24	1	
19	72 x 50 x 27	6	
20	328 x 38 x 24	2	
21	1536 x 30 x 5	1	
22	1556 x 365 x 18	1	
23	1556 x 365 x 18	1	
24	1726 x 405 x 3.2	2	

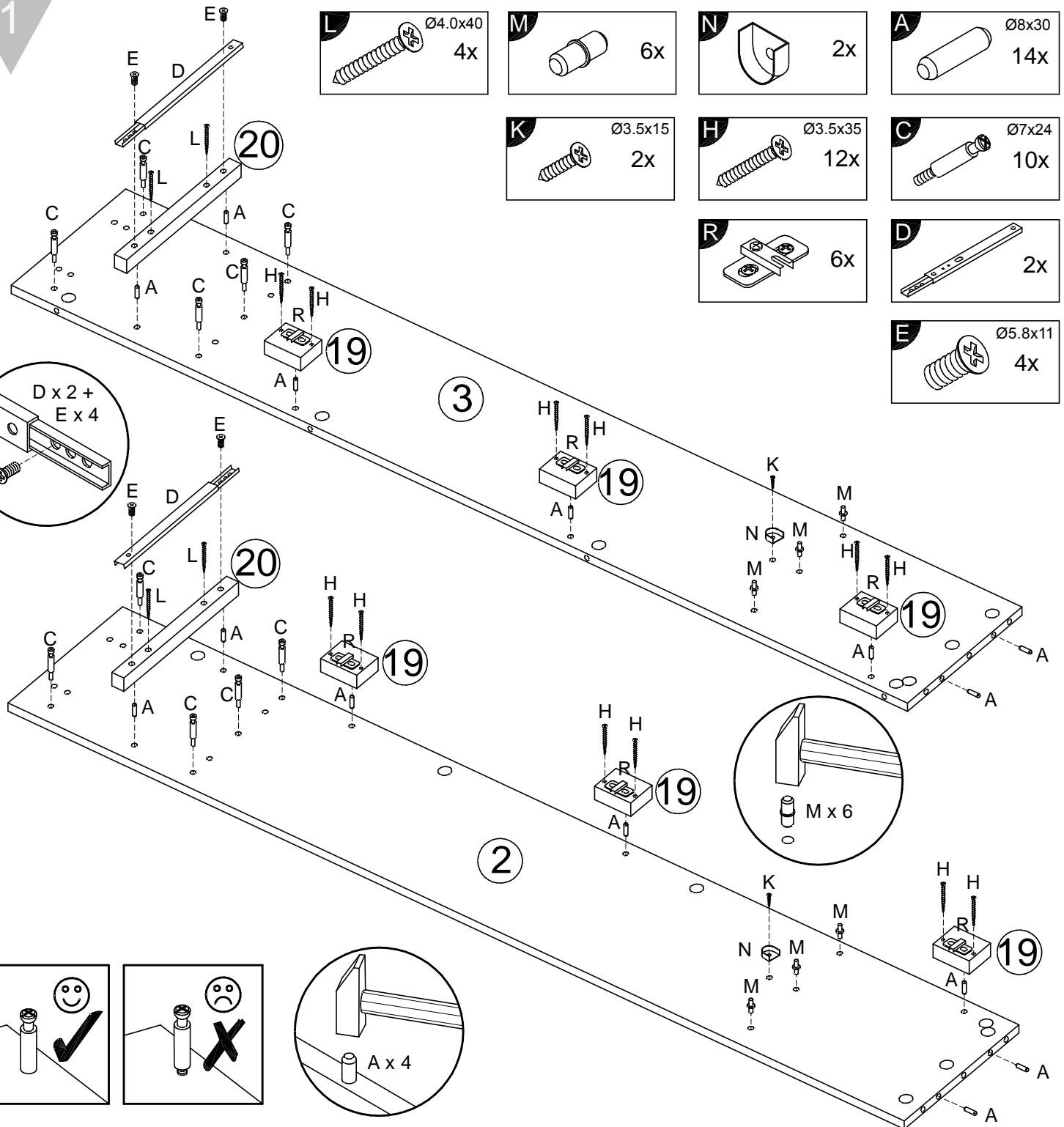
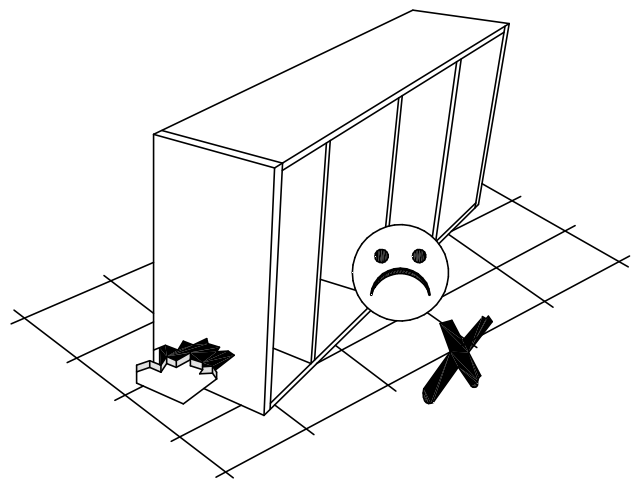
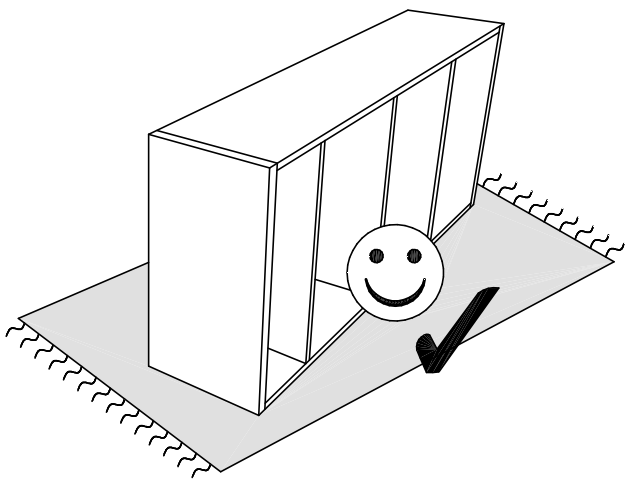

2

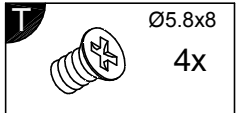
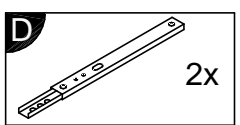
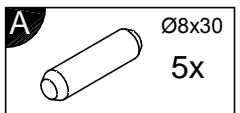
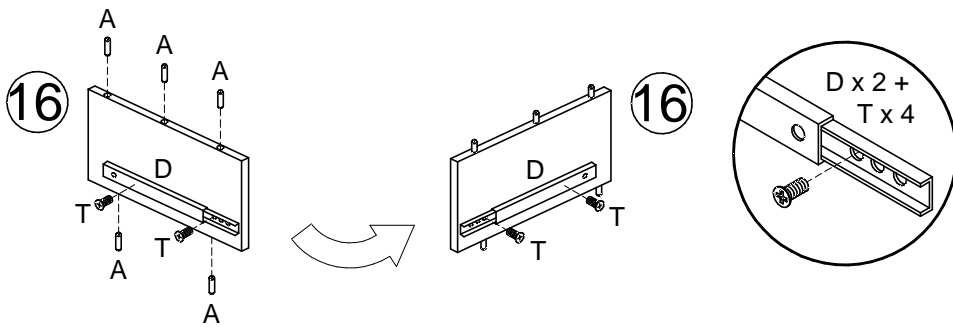

3

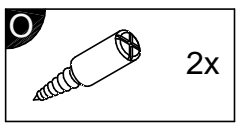
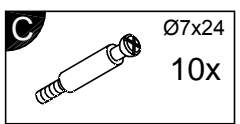
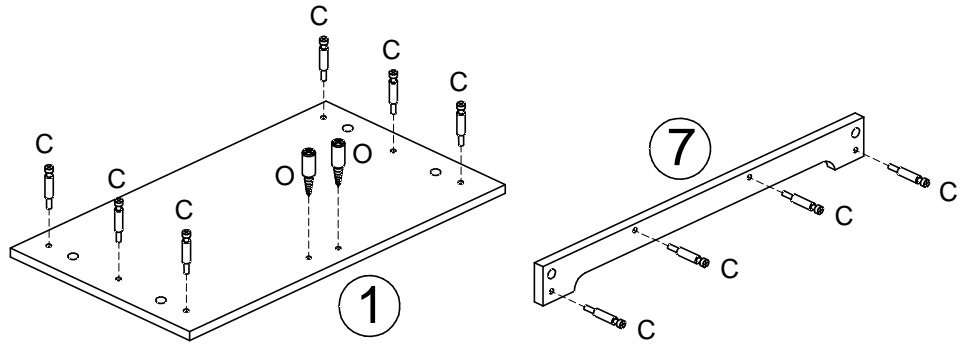

4

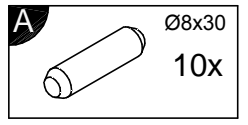
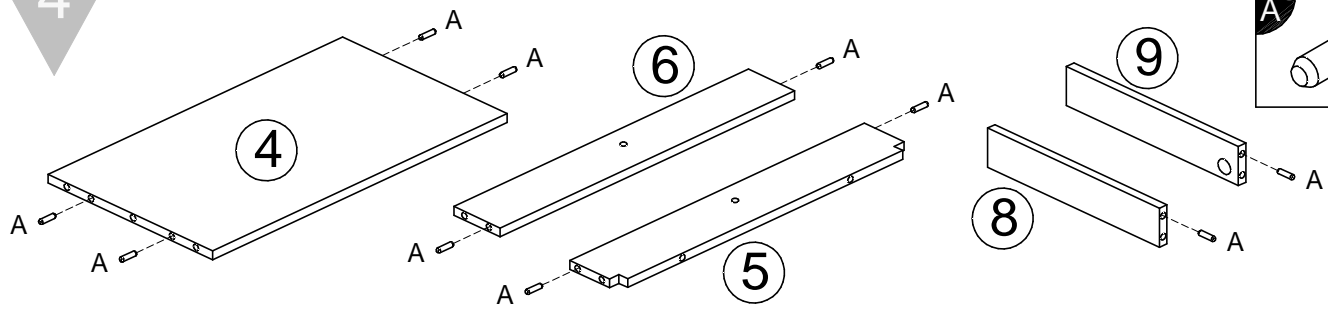

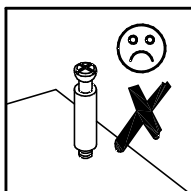
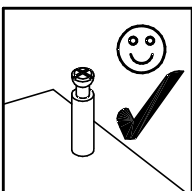
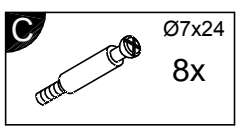
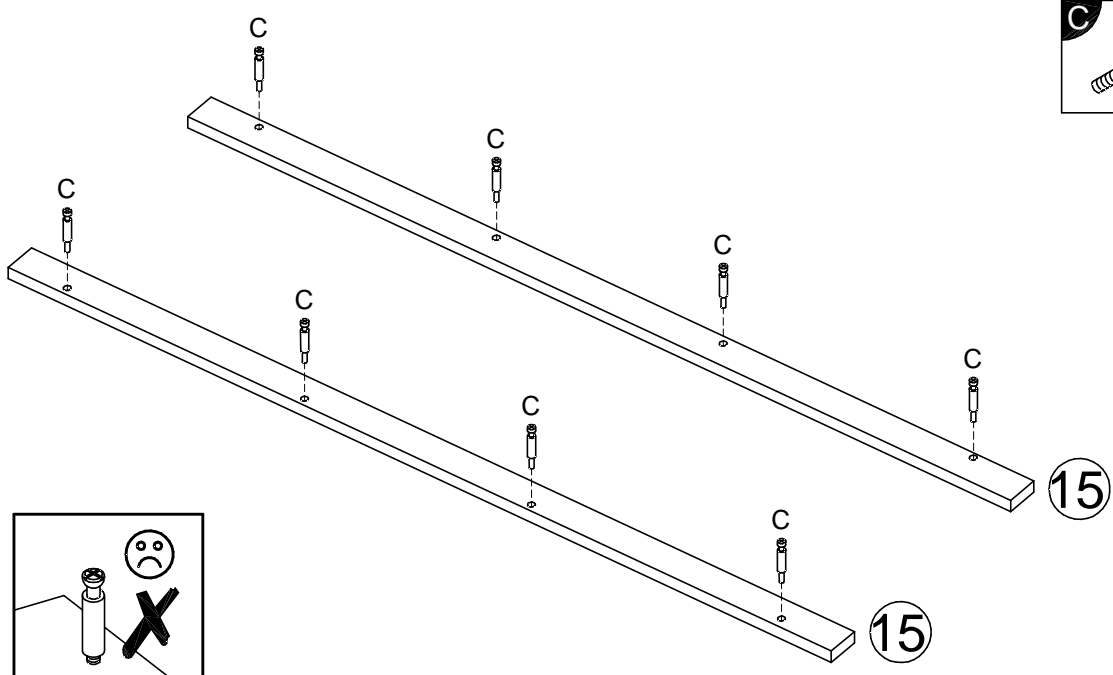

5

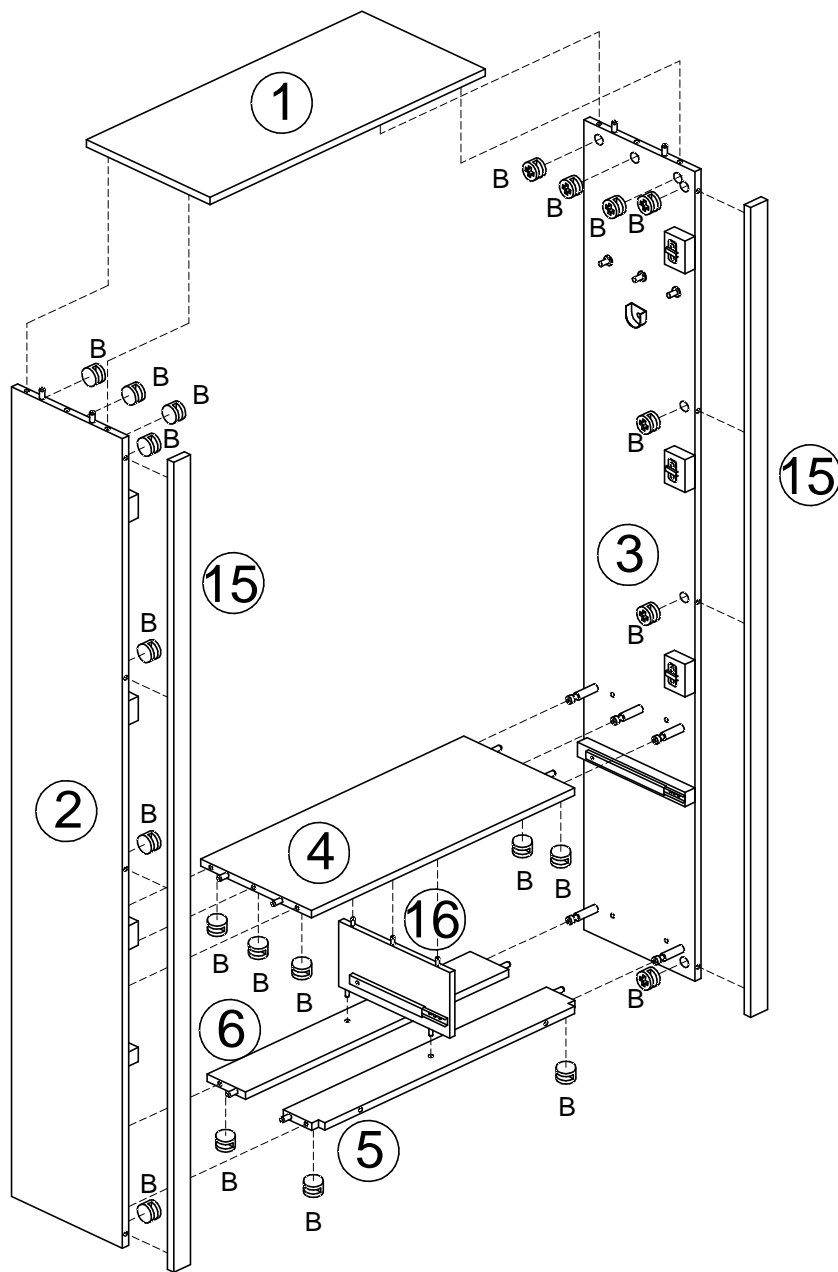



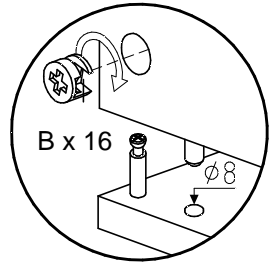

**B**   $\varnothing 15 \times 9.5$   
24x



**B**   $\varnothing 15 \times 9.5$   
4x

**H**   $\varnothing 3.5 \times 35$   
10x

**G**  2x

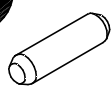
**A**   $\varnothing 8 \times 30$   
8x

**C**   $\varnothing 7 \times 24$   
4x

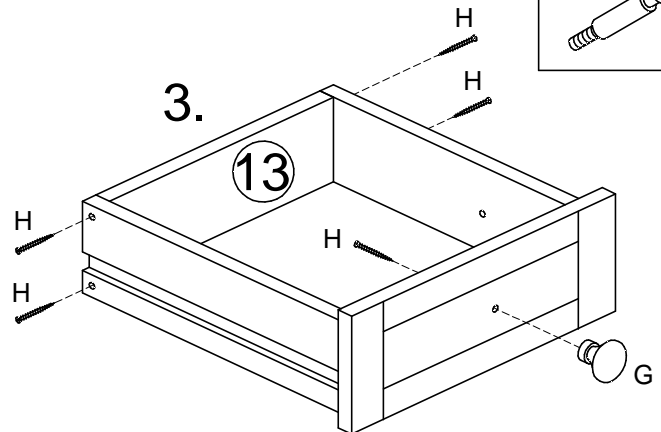
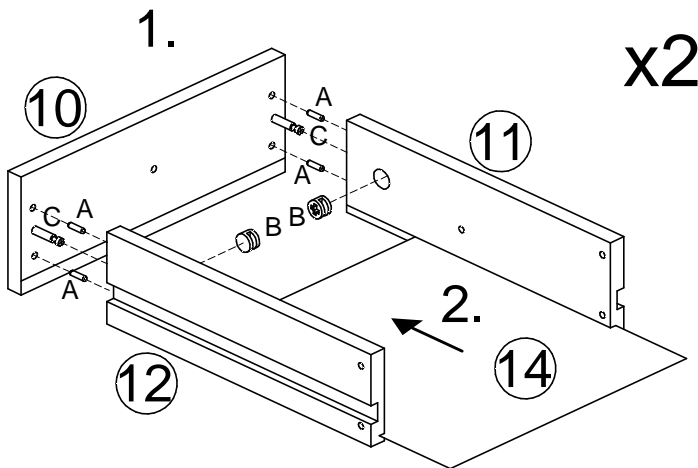

8

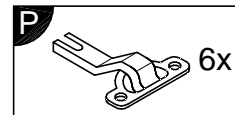
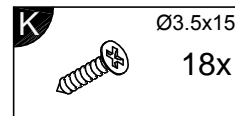
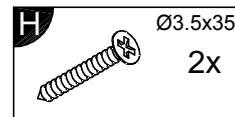
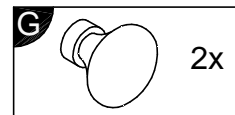
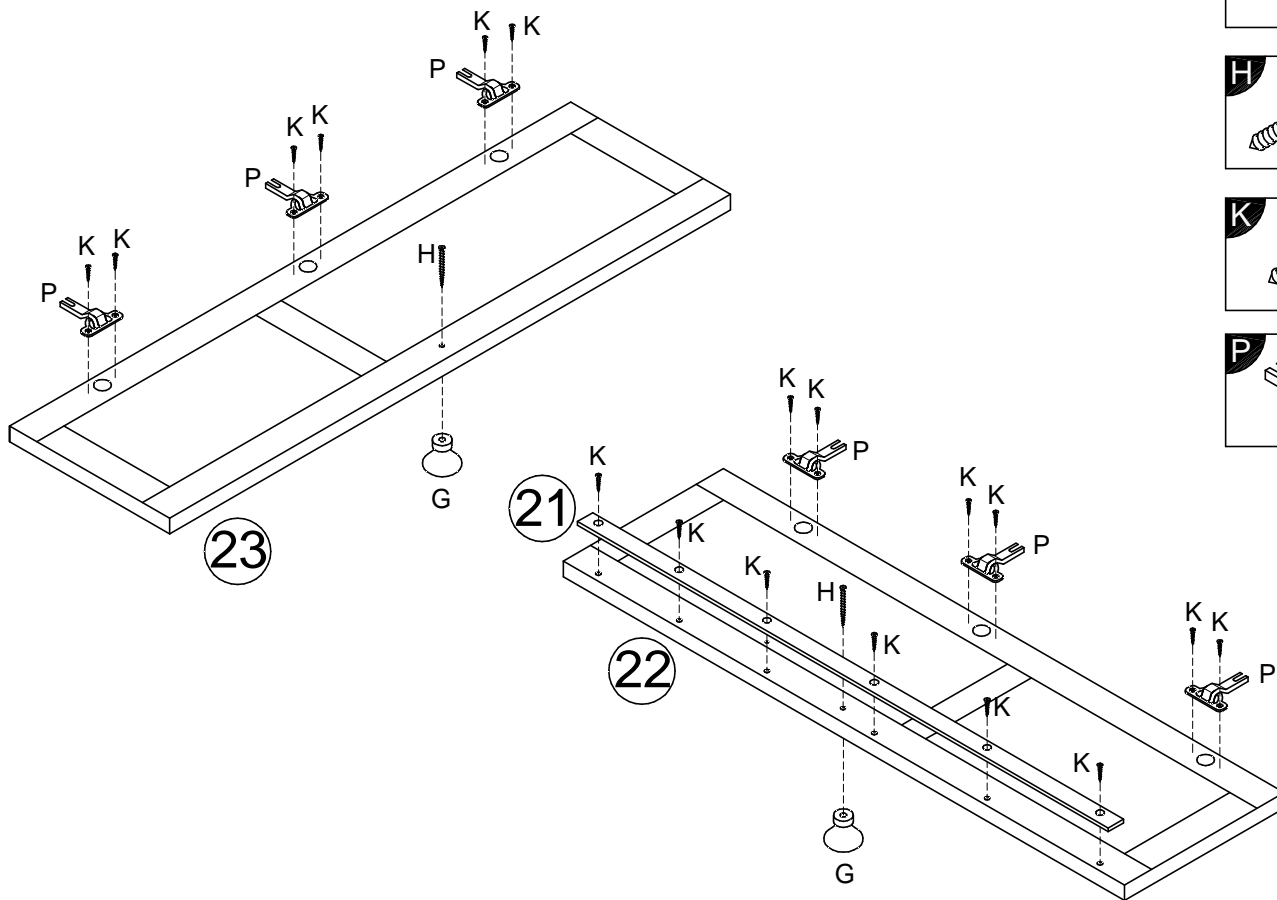

9

