

D Montageanleitung

GB Assembly instructions

CZ Montážní návod

SK Návod na montáž

FR Notice de montage

IT Istruzioni di montaggio

HU Szerelési útmutató

RO Instrucțiuni de montaj

NL Handleiding voor de montage

PL Instrukcja montażu

TR Montaj talimatı

RU Инструкция по монтажу

CORBY 1

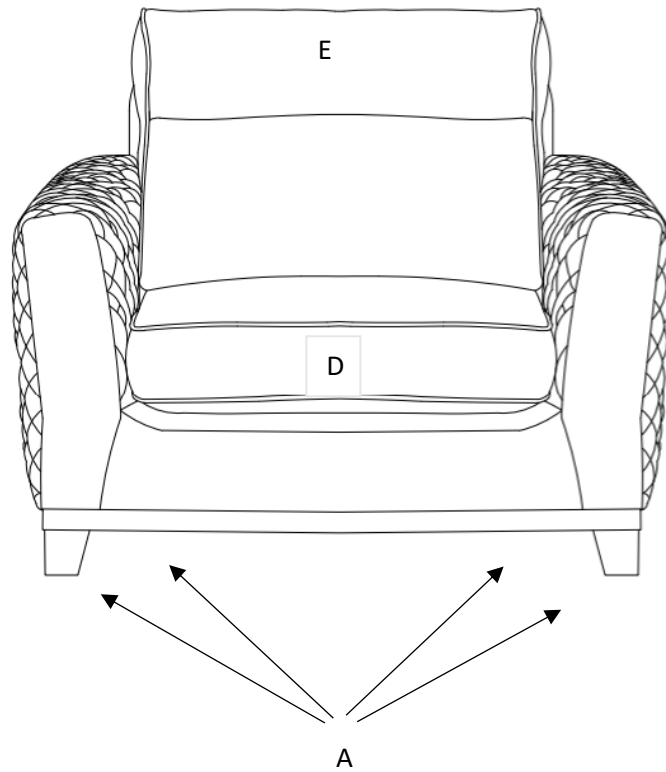
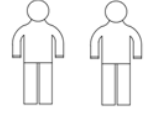

A

4x



B

M6x80

4x



C

1x

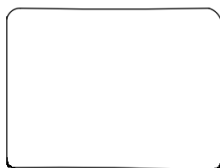

D

1x

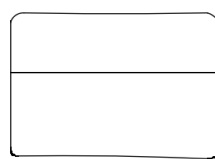

E

1x

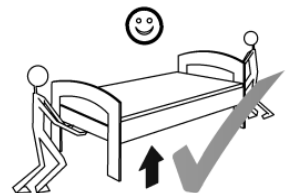
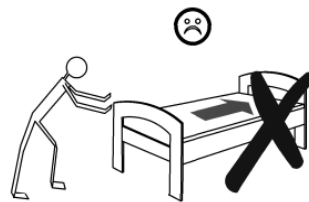
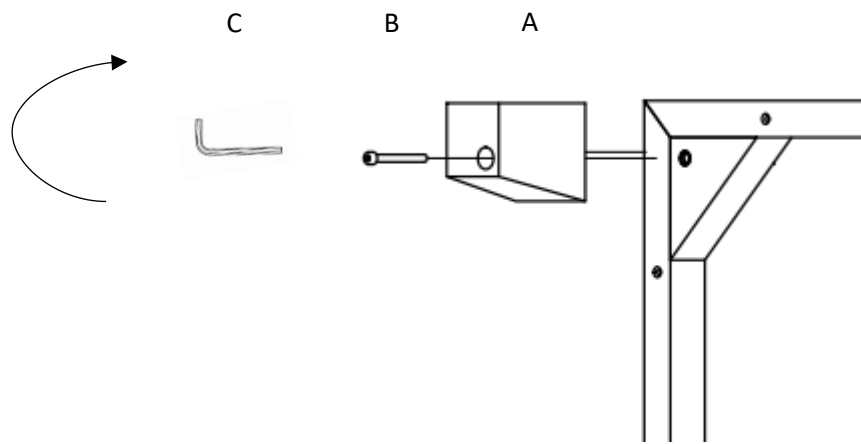
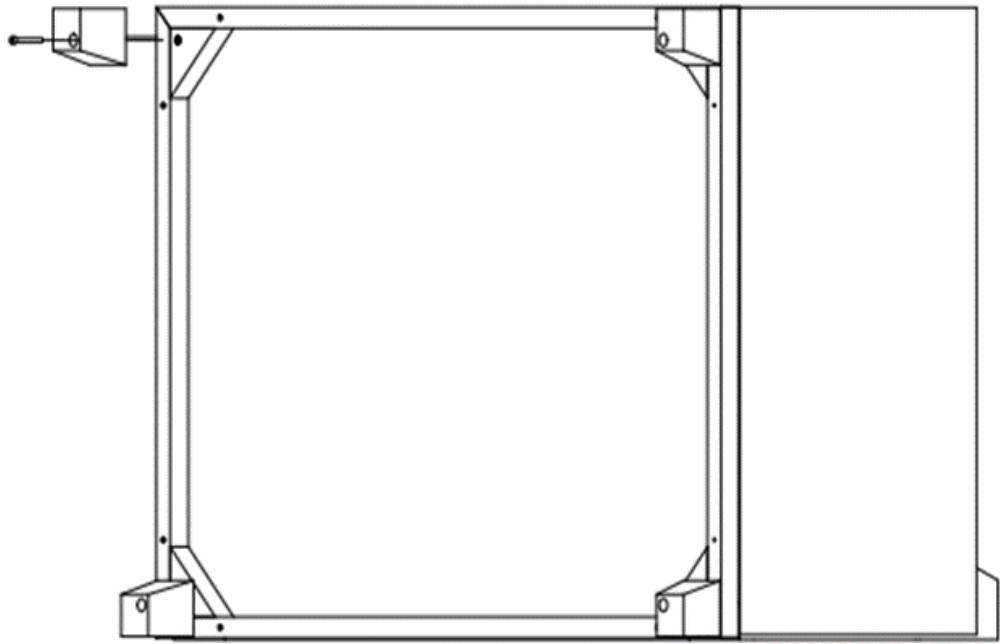

**Service • Assistenza • Dienstverlening • Serwis
Servis • Szerviz • Сервисная служба**

Name • Naam • Nazwa • İsim • Название





CORBY

Nr. • No. • Номер

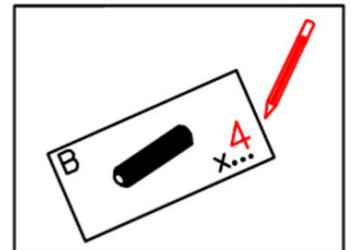
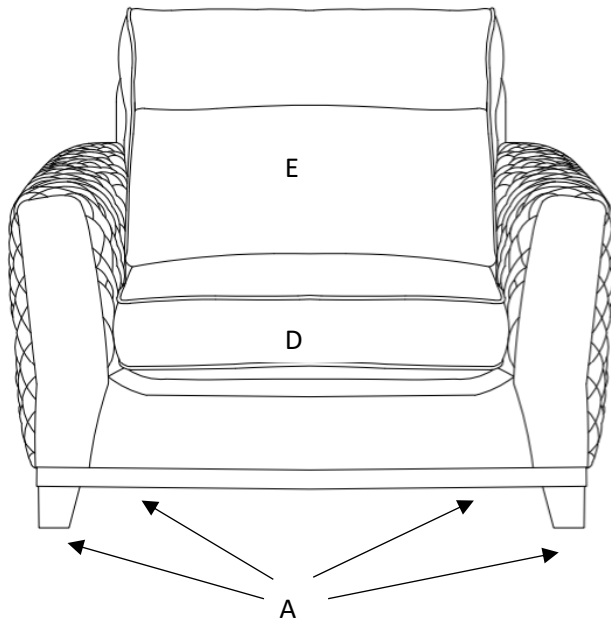
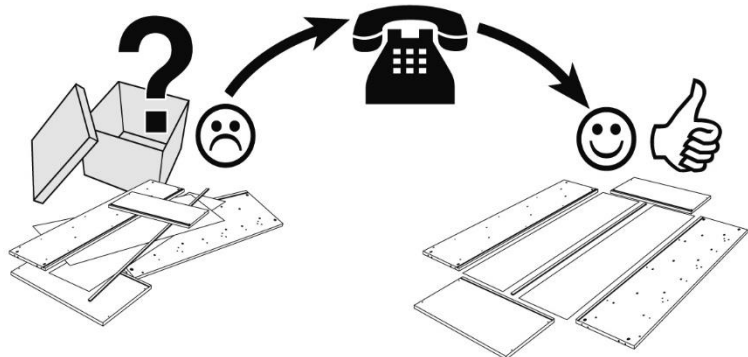
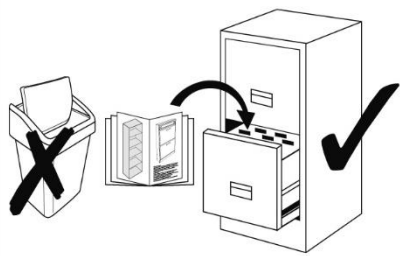
Тур • Туре • Тір • Тип

1

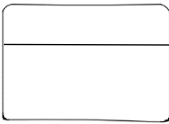

 A	 B	
 C	 D	 E